



# **ANTÍFONA PANDÉMICA**

**POEMAS VISUALES**

**2020 · 2023**

Gregorio Antolín

**SEGUNDA EDICIÓN**

**T**odos los poemas gráficos experimentales que aparecen en estas páginas, han sido publicados en los fanzines que MESETARIA EDICIONES ha sacado a la luz en estos tiempos de pánico pandémico.

En esta segunda edición, se han añadido las obras que aparecen en el número de cierre del fanzine **“Cada Vez Peor”**, publicado en el invierno de 2023.

No se incluye el poemario **“22 POEMAS EN LATA”** editado en las mismas fechas, por ser una obra publicada independiente, anexa al número cuatro del fanzine **“Cada Vez Peor”**, editado en el último mes de 2021.



**ADAGIO LIBERTARIO**



**CUARTETO DE VIENTO**



**ORGULLO RACIAL**

# SEÑALES



TOTALITARISMO



PENSAMIENTO ÚNICO

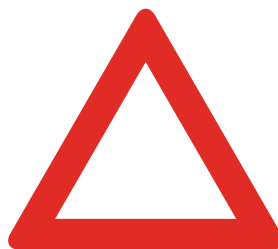

SANTÍSIMA TRINIDAD

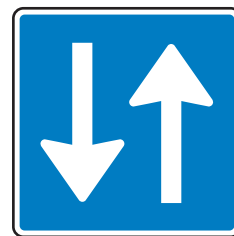

RELATIVISMO MORAL



FÍSICA CUÁNTICA



SÁBADO NOCHE



CRISIS



DECADENCIA



OBJETOS COTIDIANOS  
**CUCHARA DE DIETISTA**

# BETIKO MAITASUNA

AMOR ETERNO





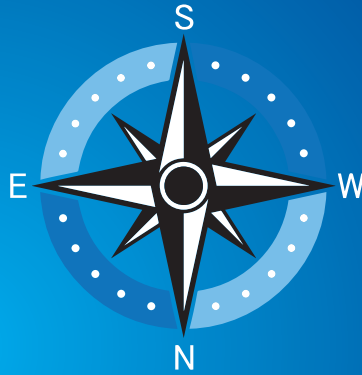

**NUESTRO NORTE  
ES EL SUR**

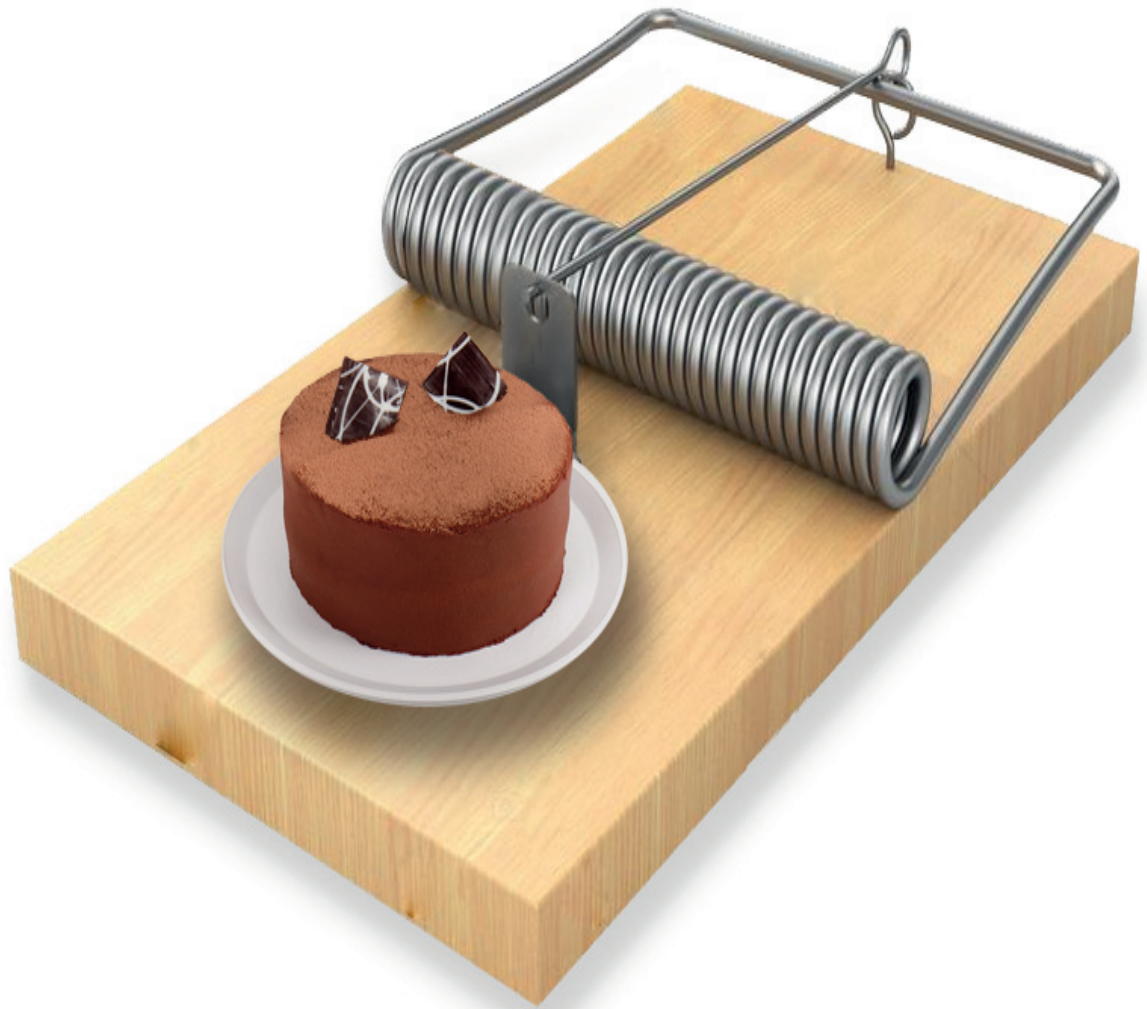

**C'EST LA VIE**



**TRAGEDIA CÓSMICA**

# POEMAS SENTIMENTALES PARA MECÁNICOS

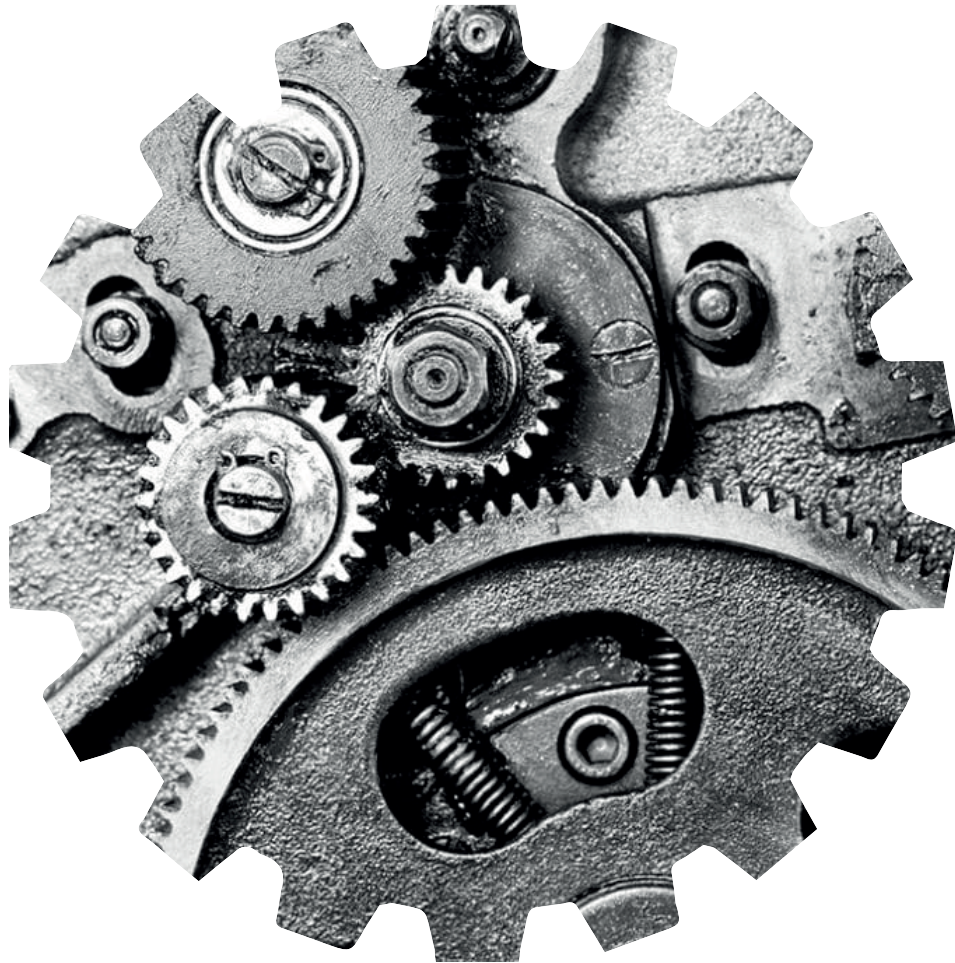

**UNA RELACIÓN COMPLEJA**

# POEMAS SENTIMENTALES PARA MECÁNICOS



**CUESTIÓN DE TIEMPO**

# POEMAS SENTIMENTALES PARA MECÁNICOS



**AÑEJAS CICATRICES**

# POEMAS SENTIMENTALES PARA MECÁNICOS



**DESCORAZONADOS**

POEMAS SENTIMENTALES PARA MECÁNICOS



**ANILLO DEL PLACER PARA MECÁNICOS**

Longer & Stronger

**SEX SHOP**



# POEMAS SENTIMENTALES PARA MECÁNICOS



**MENAJE A TROIS  
(BBC)**

# Íberos

20 CIGARRILLOS  
HEBRA



Las autoridades sanitarias advierten

**Que el humo  
ciega tus ojos**

FILTER CIGARETTES



# Marlporro

Las autoridades sanitarias advierten

**TODO LO QUE  
DA RISA ES  
SUBVERSIVO**

AMERICAN  
BLEND



# Tontuna

La autoridad sanitaria

**COMO TODA  
AUTORIDAD  
NOS LA SUDA**

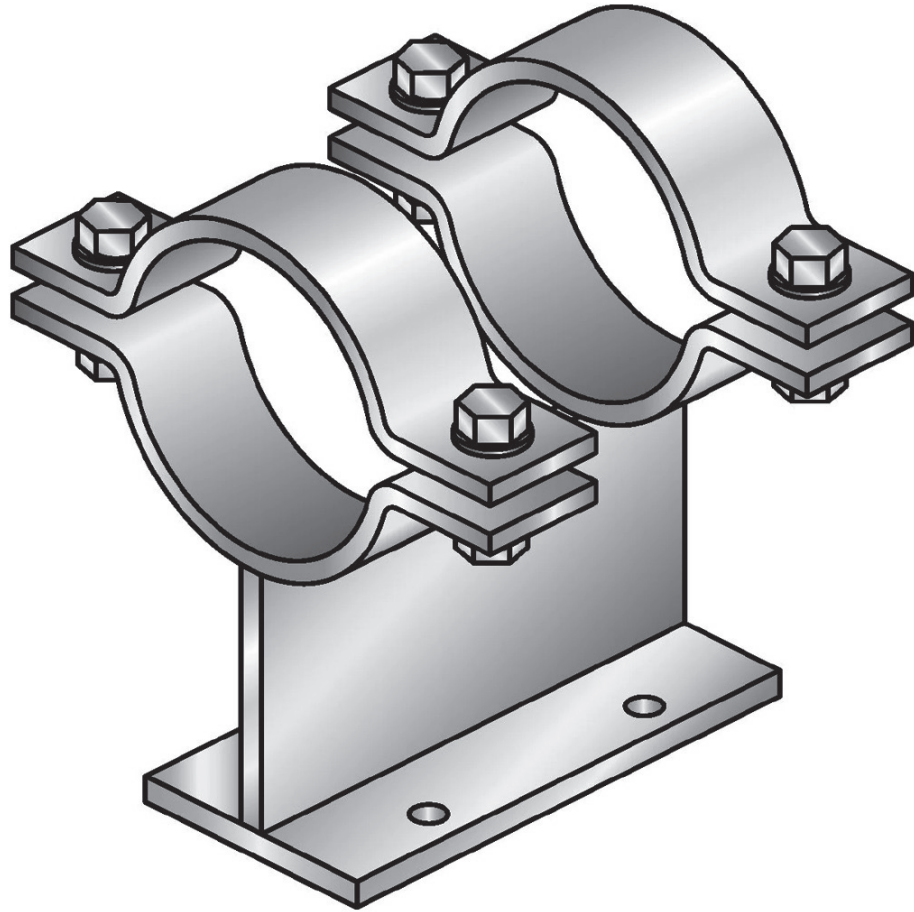

**CHANTAJE EMOCIONAL**



**TILDE VIOLENTA**



**CARTAS MARCADAS**



**SOSPECHA**





**POEMA PSICOTRÓPICO**



**TODOS LOS DÍAS SON LUNES**



**CONOCIMIENTO EMPÍRICO**

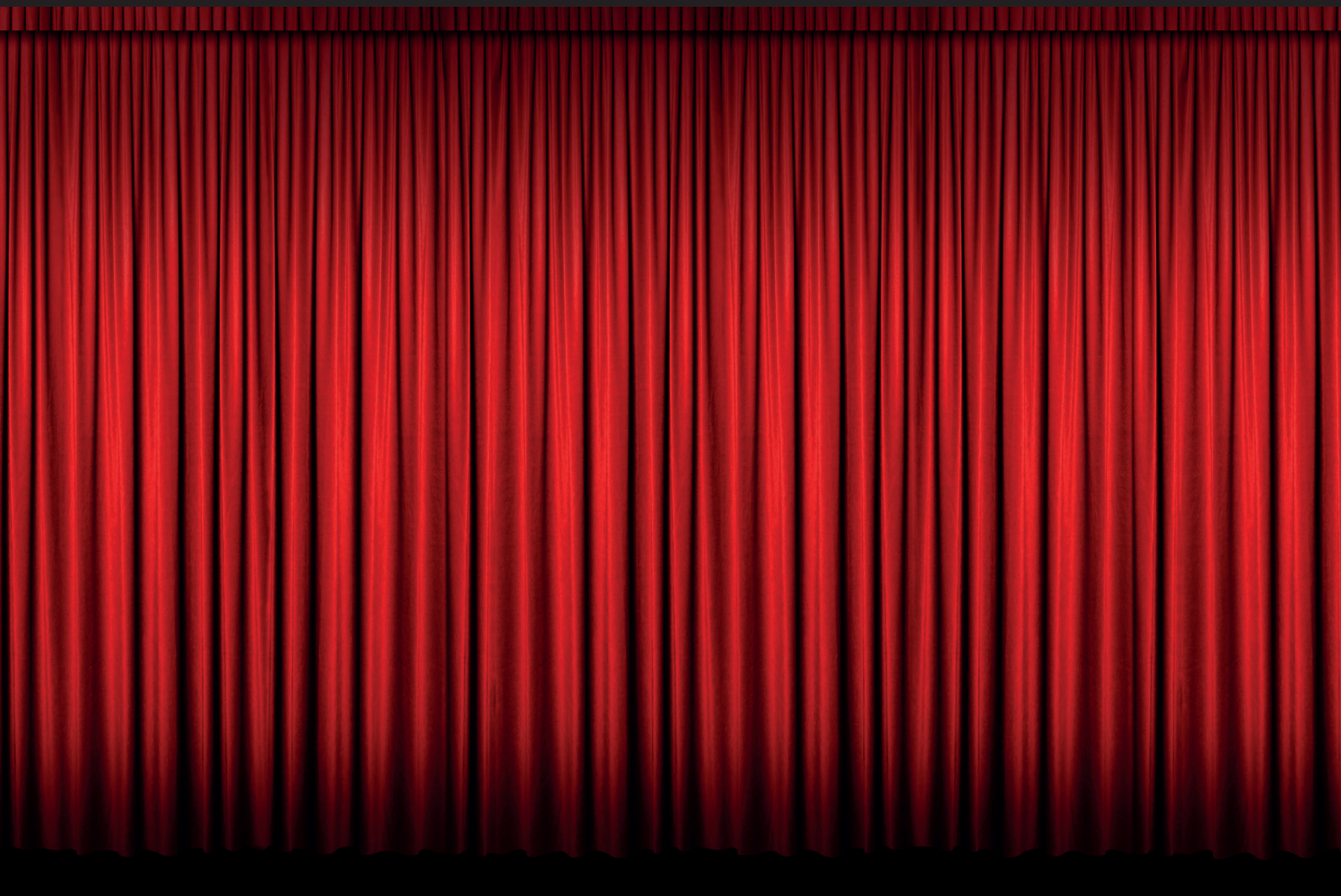

**EXITUS**

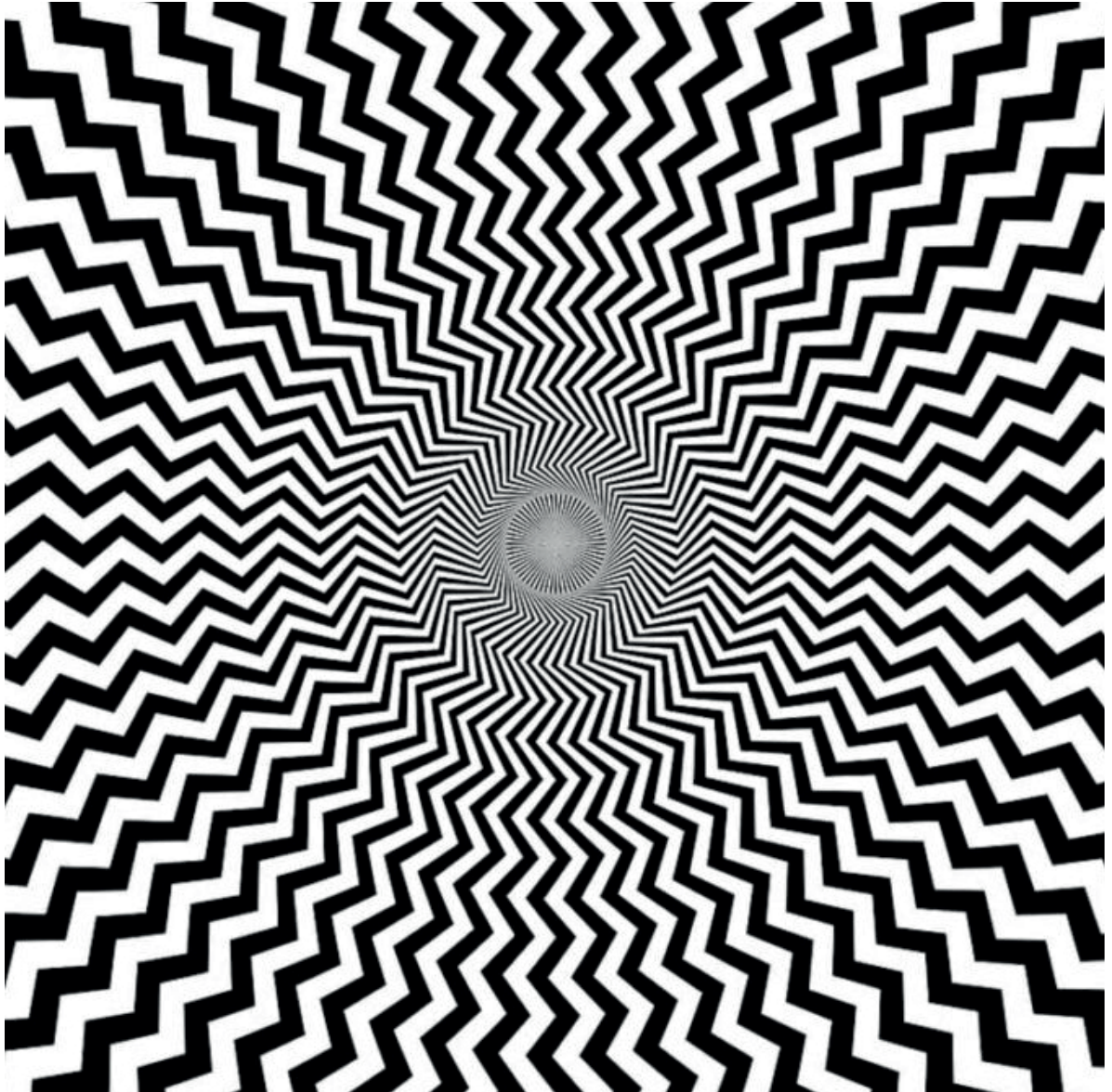

**OBSESIÓN**

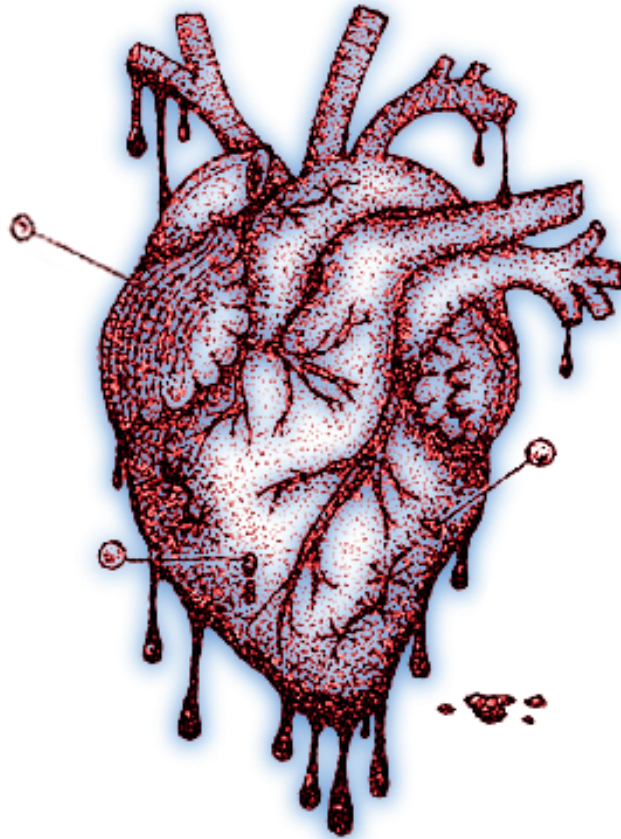

**¿QUIEN RECOGE LOS TRASTOS  
DESPUÉS DE LA FIESTA?**



**NOTICIAS DESGARRADORAS**

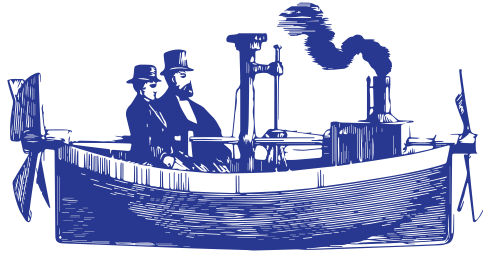

**SOLTAD LOS REMOS  
ARRIAD LAS VELAS  
INUTIL NAVEGAR**

**ÍTACA YA NO EXISTE**





**2023**